

**DRAFT REPORT**  
**May 2007**

# **Total Maximum Daily Load For Nutrients and Organic Enrichment/Low DO**

## **In Listed Tributaries to St. Louis Bay Coastal Streams Basin**

### **Hancock and Harrison Counties Mississippi**

Prepared By

Mississippi Department of Environmental Quality  
Office of Pollution Control  
Standards, Modeling, and TMDL Branch

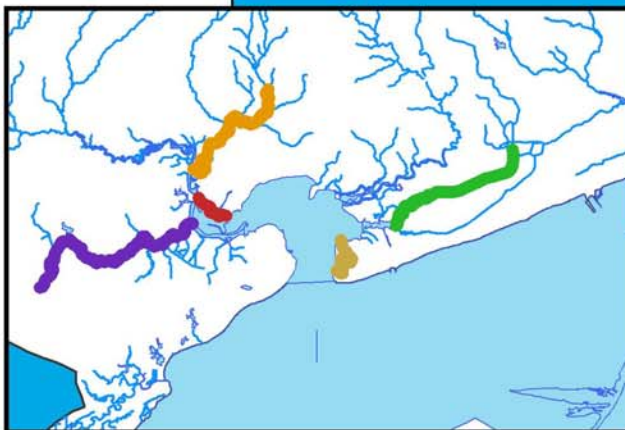

MDEQ  
PO Box 10385  
Jackson, MS 39289-0385  
(601) 961-5171  
[www.deq.state.ms.us](http://www.deq.state.ms.us)

## FOREWORD

This report has been prepared in accordance with the schedule contained within the federal consent decree dated December 22, 1998. The report contains one or more Total Maximum Daily Loads (TMDLs) for water body segments found on Mississippi's 1996 §303(d) List of Impaired Waterbodies. Because of the accelerated schedule required by the consent decree, many of these TMDLs have been prepared out of sequence with the State's rotating basin approach. The implementation of the TMDLs contained herein will be prioritized within Mississippi's rotating basin approach.

The amount and quality of the data on which this report is based are limited. As additional information becomes available, the TMDLs may be updated. Such additional information may include water quality and quantity data, changes in pollutant loadings, or changes in landuse within the watershed. In some cases, additional water quality data may indicate that no impairment exists.

**Conversion Factors**

To convert from	To	Multiply by	To convert from	To	Multiply by
mile <sup>2</sup>	acre	640	acre	ft <sup>2</sup>	43560
km <sup>2</sup>	acre	247.1	days	seconds	86400
m <sup>3</sup>	ft <sup>3</sup>	35.3	meters	feet	3.28
ft <sup>3</sup>	gallons	7.48	ft <sup>3</sup>	gallons	7.48
ft <sup>3</sup>	liters	28.3	hectares	acres	2.47
cfs	gal/min	448.8	miles	meters	1609.3
cfs	MGD	0.646	tonnes	tons	1.1
m <sup>3</sup>	gallons	264.2	µg/l * cfs	gm/day	2.45
m <sup>3</sup>	liters	1000	µg/l * MGD	gm/day	3.79

Fraction	Prefix	Symbol	Multiple	Prefix	Symbol
10 <sup>-1</sup>	deci	d	10	deka	da
10 <sup>-2</sup>	centi	c	10 <sup>2</sup>	hecto	h
10 <sup>-3</sup>	milli	m	10 <sup>3</sup>	kilo	k
10 <sup>-6</sup>	micro	:	10 <sup>6</sup>	mega	M
10 <sup>-9</sup>	nano	n	10 <sup>9</sup>	giga	G
10 <sup>-12</sup>	pico	p	10 <sup>12</sup>	tera	T
10 <sup>-15</sup>	femto	f	10 <sup>15</sup>	peta	P
10 <sup>-18</sup>	atto	a	10 <sup>18</sup>	exa	E

# CONTENTS

TMDL INFORMATION PAGE.....	5
EXECUTIVE SUMMARY .....	7
INTRODUCTION .....	9
1.1 Background.....	9
1.2 Applicable Water Body Segment Use .....	10
1.3 Applicable Water Body Segment Standard .....	10
1.4 Selection of a Critical Condition.....	11
1.5 Selection of a TMDL Endpoint.....	11
WATER BODY ASSESSMENT .....	13
2.1 Discussion of Instream Water Quality Data .....	13
2.2 Assessment of Nonpoint Sources.....	13
2.3 Assessment of Point Sources .....	17
MODELING PROCEDURE: LINKING THE SOURCES TO THE ENDPOINT.....	19
3.1 Modeling Framework Selection.....	19
3.2 Model Setup.....	20
3.3 Source Representation .....	23
3.4 Model Calibration .....	25
3.5 Model Results for DO and BOD.....	26
3.5.1 Regulatory Load Scenario.....	26
3.5.2 Maximum Load Scenario.....	27
3.6 Estimated Existing Load for Nutrients .....	28
ALLOCATION.....	32
4.1 Wasteload Allocation.....	32
4.2 Load Allocation .....	32
4.3 Incorporation of a Margin of Safety .....	33
4.4 Seasonality .....	33
4.5 Calculation of the TMDL.....	34
4.6 Reasonable Assurance .....	34
CONCLUSION.....	35
5.1 Public Participation.....	35
REFERENCES .....	36
DEFINITIONS.....	39
ABBREVIATIONS .....	42

## FIGURES

Figure 1. St. Louis Bay Tributaries 303(d) Listed Segments .....	10
Figure 2. St. Louis Bay Watershed pre-Katrina Land Use Summary (from Huddleston, et. al., 2003) .....	14
Figure 3. St. Louis Bay Watershed pre-Katrina Land Use Distribution (from Huddleston et. al., 2003) .....	15
Figure 4. St. Louis Bay Subwatershed Delineation (from Huddleston, et. al., 2003) .....	21
Figure 5. St. Louis Bay modeling domain and segmentation (from Huddleston, et. al., 2003) ...	23
Figure 6. State variable interactions in the nutrient dynamics model (from Huddleston, et. al., 2003) .....	25
Figure 7. Model Output for DO in Bayou LaCroix, Regulatory Load Scenario .....	26
Figure 8. Model Output for DO in Rotten Bayou, Regulatory Load Scenario .....	27
Figure 9. Model Output for Bayou LaCroix for DO, Maximum Load Scenario .....	27
Figure 10. Model Output for Rotten Bayou for DO, Maximum Load Scenario .....	28
Figure 11. Simulated TN concentrations in Bayou La Croix under critical conditions .....	28
Figure 12. Simulated TN concentrations in Canal Number 3 under critical conditions .....	29
Figure 13. Simulated TN concentrations in Rotten Bayou under critical conditions .....	29

## TABLES

i. Listing Information .....	5
ii. Water Quality Standard .....	5
iii. NPDES Facilities .....	5
iv. Total Maximum Daily Load for TBODu and Nutrients* .....	6
Table 1. NPDES Permitted Facilities Treatment Types .....	17
Table 2. Identified NPDES Permitted Facilities .....	18
Table 3. Subwatershed Summary for the St. Louis Bay Study Area .....	22
Table 4. Boundary conditions for the Bay Model(From Huddleston, et. al., 2007) .....	25
Table 5. Estimated Existing Total Nitrogen Loads for modeled tributaries to St. Louis Bay .....	29
Table 6. Estimated Existing Total Nitrogen Loads for other tributaries to St. Louis Bay .....	30
Table 7. NPDES Permitted Facilities Treatment Types with Nitrogen Estimates .....	30
Table 8. NPDES Permitted Facilities Treatment Types with Phosphorus Estimates .....	31
Table 9. TBODu Load Allocation, Maximum Scenario .....	32
Table 10. Load Allocation for Estimated TN and TP .....	33
Table 11. Calculation of Explicit MOS for TBODu in lbs/day .....	33
Table 12. TMDL for TBODu in Bayou LaCroix and Rotten Bayou .....	34
Table 13. TMDLs for Nutrients in the tributaries to St. Louis Bay .....	34

# TMDL INFORMATION PAGE

## i. Listing Information

Name	ID	County	HUC	Cause	Mon/Eval
Bayou La Croix	MS115BLCE	Hancock	03170009	OE/Low DO & Nutrients	Evaluated
Near Waveland from headwaters to mouth at Jourdan River					
Canal Number 3	MS118BPE	Harrison	03170009	Nutrients	Evaluated
Near Pass Christian from Canal Number 2 confluence with Turkey Creek to mouth at Bayou Portage					
Cutoff Bayou	MS114JE	Hancock	03170009	Nutrients	Evaluated
From Headwaters of Cutoff Bayou to confluence with Jourdan River					
Mallini Bayou	MS118MBE	Harrison	03170009	Nutrients	Evaluated
At Pass Christian from southern entrance near Highway 90 to northern entrance at St. Louis Bay					
Rotten Bayou	MS113JE	Hancock, Harrison	03170009	OE/Low DO & Nutrients	Evaluated
Near Kiln from Headwaters to confluence with Jourdan River					

## ii. Water Quality Standard

Parameter	Beneficial use	Water Quality Criteria
Dissolved Oxygen	Aquatic Life Support	DO concentrations shall be maintained at a daily average of not less than 5.0 mg/l with an instantaneous minimum of not less than 4.0 mg/l
Nutrients	Aquatic Life Support	“Waters shall be free from materials attributable to municipal, industrial, agricultural or other discharges producing color, odor, taste, total suspended or dissolved solids, sediment, turbidity, or other conditions in such degree as to create a nuisance, render the waters injurious to public health, recreation or to aquatic life and wildlife or adversely affect the palatability of fish, aesthetic quality, or impair the water for any designated use.”

## iii. NPDES Facilities

Facility Name	Facility ID	Receiving Water
Long Beach Industrial District Park	MS0022373	Ditch to Canal #1, then Johnson Bayou
Total Environmental Solutions Inc, Discovery Bay Subdivision	MS0021865	Bayou Portage
Hancock County Utility Authority, Waveland POTW	MS0027847	Edwards Bayou
Diamondhead Water and Sewer District	MS0046078	Jourdan River
Five Star RV Resort Park, Outfall 001	MS0035131	Unnamed tributary of the Wolf River
Five Star RV Resort Park, Outfall 002	MS0035131	Unnamed tributary of the Wolf River
Jourdan River Shores Subdivision	MS0022870	Jourdan River
Harrison County Wastewater and Solid Waste Management Authority, Long Beach and Pass Christian	MS0043141	Bayou Portage
DuPont DeLisle Facility	MS0027294	Ditch thence St. Louis Bay
Harrison County Utility Authority, Delisle Wastewater Treatment Facility	MS0052574	Unnamed tributary of De Lisle Bayou
Hancock County Schools, East Hancock Elementary School	MS0057070	Unnamed tributary of Jourdan River

**iv. Total Maximum Daily Load for TBODu and Nutrients\***

<b>Water body</b>	<b>Pollutant</b>	<b>WLA lbs/day</b>	<b>LA lbs/day</b>	<b>MOS</b>	<b>TMDL lbs/day</b>
Bayou La Croix	TBODu	0	626	160	786
	Total Nitrogen	0	7,871	Implicit	7,871
	Total Phosphorous	0	525	Implicit	525
Canal Number 3	Total Nitrogen	0	715	Implicit	715
	Total Phosphorous	0	48	Implicit	48
Cutoff Bayou	Total Nitrogen	0	320	Implicit	320
	Total Phosphorous	0	110	Implicit	110
Mallini Bayou	Total Nitrogen	0	92	Implicit	92
	Total Phosphorous	0	32	Implicit	32
Rotten Bayou	TBODu	0	671	2,588	3,259
	Total Nitrogen	0	5,810	Implicit	5,810
	Total Phosphorous	0	387	Implicit	387

\*The State of Mississippi is in the process of developing numeric nutrient criteria in accordance with an EPA approved work plan for nutrient criteria development.

## EXECUTIVE SUMMARY

This TMDL was developed for the tributaries to St. Louis Bay (Bayou LaCroix, Canal Number 3, Cutoff Bayou, Mallini Bayou, and Rotten Bayou) which are on the Mississippi 2004 §303(d) List of Water Bodies as evaluated water body segments. These water bodies were originally placed on the §303(d) List based on anecdotal information. Mississippi conducted a survey of district conservationists (DCs) in 1988 and 1989 to find candidate watersheds for future §319 funding opportunities. MDEQ requested each DC identify the watersheds of concern in their county based on available information including land use. Numerous DCs responded to the survey, and MDEQ created Mississippi's §319 List based on these surveys.

As a result of the surveys, Bayou LaCroix, Canal Number 3, Cutoff Bayou, Mallini Bayou, and Rotten Bayou were listed for organic enrichment/low DO and/or nutrients. Mississippi currently does not have water quality standards for allowable nutrient concentrations. This TMDL will be developed for total biochemical oxygen demand, ultimate (TBODu), total nitrogen (TN), and total phosphorous (TP).

Bayou LaCroix, Canal Number 3, Cutoff Bayou, Mallini Bayou, and Rotten Bayou are estuarine water bodies located on the Mississippi Gulf Coast in HUC 03170009. The water bodies drain small watersheds that are primarily wetlands with some suburban areas of Waveland, Bay St. Louis, and Pass Christian. This area was heavily devastated by Hurricane Katrina in August of 2005.

The TMDLs for these water bodies are based on a monitoring and modeling project that studied St. Louis Bay and its tributaries. The models used included, Better Assessment Science Integrating Point and Nonpoint Sources (BASINS 3.0), the windows implementation of the Hydrologic Simulation Program - Fortran (WinHSPF), the hydrodynamic version of the Environmental Fluid Dynamics Code (EFDC\_Hydro), and Water Analysis Simulation Program (WASP6). The coupled modeling system was developed by the Plant and Soil Sciences Department at Mississippi State University (MSU) and the Civil and Environmental Engineering Department at Tennessee Technological University (TTU). The model calibration and verification are based on water quality studies of the area which were conducted in 1998, 1999, and 2001. The modeling study is described in two extensive reports titled, Development of a Comprehensive Water Quality Model of the St. Louis Bay Estuary and Watershed (Huddleston, et. al., 2003) and Refinement and Calibration of the Developed Comprehensive Water Quality Model for St. Louis Bay Estuary (Huddleston, et. al., 2006).

Loading estimates of organic substances and nutrients from non-point sources in the watershed were based upon background concentrations measured during the model calibration/verification studies of the St. Louis Bay watershed. Modeling results from a wet year and a dry year were compared. The critical period for both pollutants, TBODu and nutrients, was the dry year.

For the two water bodies listed for organic enrichment/low DO, Bayou La Croix and Rotten Bayou, the TMDL for organic enrichment was quantified in terms of TBODu. According to the model, the current TBODu load in the water body does not exceed the assimilative capacity of

either water body for organic material. Therefore, no reductions in the current permitted loads of organic material are needed for this TMDL report in order to meet water quality limits.

All of the water bodies in this TMDL are listed for nutrients. This TMDL will provide an estimate of the total nitrogen (TN) and total phosphorus (TP) allowable in the water bodies. Mississippi does not have water quality standards for allowable nutrient concentrations. MDEQ currently has a Nutrient Task Force (NTF) working on the development of criteria for nutrients. A threshold concentration of 1.5 mg/l is the applicable target for TN and 0.1 mg/l for TP for water bodies located in the St. Louis Bay watershed (Thornton, 2007). MDEQ is presenting these concentrations as preliminary target values for TMDL development which are subject to revision after the development of numeric nutrient criteria. The Modeling results and estimated threshold concentrations indicate reductions of TN are needed.

On August 29, 2005 Hurricane Katrina struck the Gulf Coast and was especially devastating to the western portion of the Mississippi Coast where St. Louis Bay and these tributaries are located. Water bodies in the Coastal Streams Basin were required by the Federal Consent Decree to have TMDLs completed by EPA by June 30, 2006. Prior to the storm, MDEQ completed most of the TMDLs for the coastal basin. Nine water body segments, including the five in this TMDL, were not finalized when the hurricane struck. The federal court agreed to a one year extension of the due date for these listings. Long lasting impacts to the St. Louis Bay watershed will be felt due to significant changes in the location of population resettlement and of the rebuilding of infrastructure.

# INTRODUCTION

## 1.1 Background

Bayou LaCroix, Canal Number 3, Cutoff Bayou, Mallini Bayou, and Rotten Bayou were originally placed on the §303(d) List based on anecdotal information. Mississippi conducted a survey of district conservationists (DCs) in 1988 and 1989 to find candidate watersheds for future §319 funding opportunities. MDEQ requested each DC identify the watersheds of concern in their county based on available information including land use. Numerous DCs responded to the survey, and MDEQ created Mississippi's §319 List based on these surveys.

In 1992, MDEQ compiled a §303(d) List based, in part, on the §319 List of watersheds of concern. Therefore, water bodies were included on the §303(d) List based on speculation and not water quality monitoring data. MDEQ uses the term "evaluated" to describe these water bodies that were placed on the §303(d) List without monitoring data. At the time, MDEQ considered the evaluated listings from the §319 survey as a placeholder for future monitoring to determine if there was impairment in the watershed. The surveys asked for the presence of agriculture, urban areas, or forestry in the watershed. MDEQ interpreted potential pollutants present on these land uses and listed several broad potential pollutant categories based on the survey results. These water bodies remain listed for organic enrichment/low DO and/or nutrients based on the survey results. This TMDL will provide an estimate of TBODu and/or TN and TP allowable in the water bodies.

The identification of water bodies not meeting their designated use and the development of total maximum daily loads (TMDLs) for those water bodies are required by §303(d) of the Clean Water Act and the Environmental Protection Agency's (EPA) Water Quality Planning and Management Regulations (40 CFR part 130). The TMDL process is designed to restore and maintain the quality of those impaired water bodies through the establishment of pollutant specific allowable loads. This TMDL has been developed for the evaluated §303(d) Listed segments shown in Figure 1.

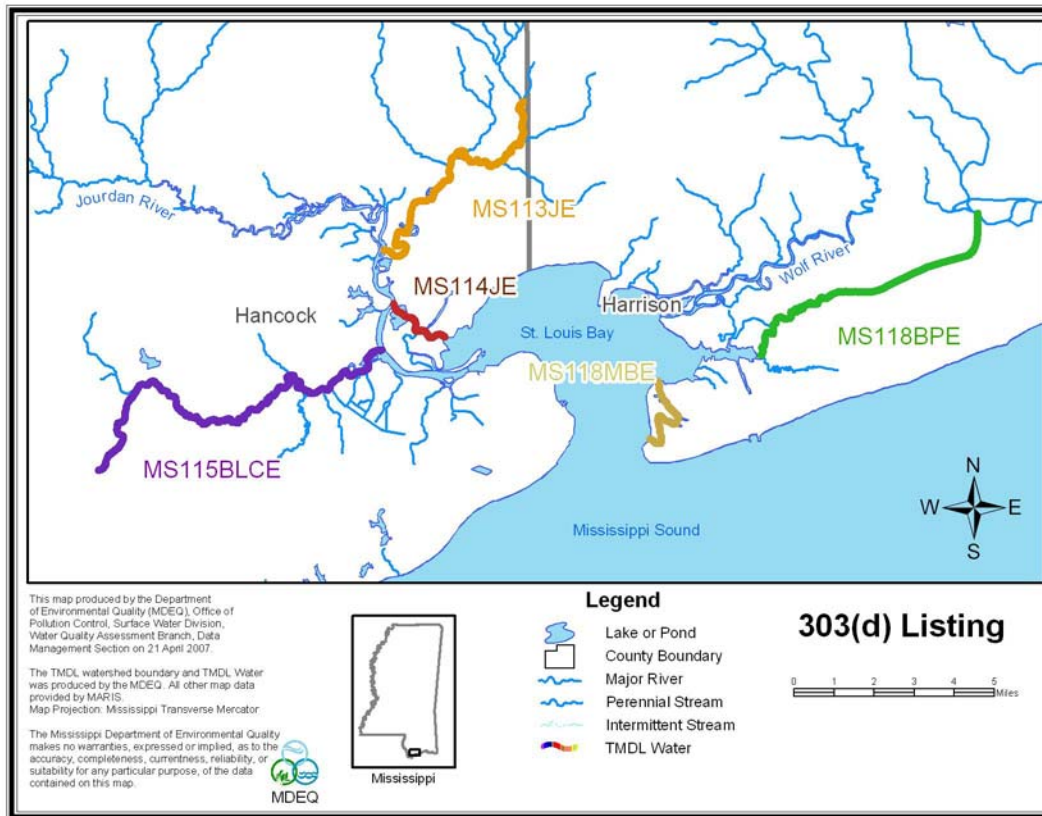

Figure 1. St. Louis Bay Tributaries 303(d) Listed Segments

## 1.2 Applicable Water Body Segment Use

The water use classifications are established by the State of Mississippi in the document *Water Quality Criteria for Intrastate, Interstate and Coastal Waters* (MDEQ, 2002). The designated beneficial use for the § 303(d) Listed segments of Bayou LaCroix, Canal Number 3, Cutoff Bayou, Mallini Bayou, and Rotten Bayou is fish and wildlife support.

## 1.3 Applicable Water Body Segment Standard

The applicable standard specifies that the dissolved oxygen (DO) concentrations shall be maintained at a daily average of not less than 5.0 mg/l with an instantaneous minimum of not less than 4.0 mg/l. This water quality standard will be used as a targeted endpoint to evaluate impairments and establish this TBODu TMDL.

Mississippi's current standards contain a narrative criteria that can be applied to nutrients which states "*Waters shall be free from materials attributable to municipal, industrial, agricultural, or other discharges producing color, odor, taste, total suspended or dissolved solids, sediment, turbidity, or other conditions in such degree as to create a nuisance, render the waters injurious to public health, recreation, or to aquatic life and wildlife, or adversely affect the palatability of fish, aesthetic quality, or impair the waters for any designated use* (MDEQ, 2002)." In the 1999 Protocol for Developing Nutrient TMDLs, EPA suggests several methods for the development of numeric criteria for nutrients (USEPA, 1999). In accordance with the 1999 Protocol, "The target

value for the chosen indicator can be based on: comparison to similar but unimpaired waters; user surveys; empirical data summarized in classification systems; literature values; or professional judgment.” The threshold values for the TN (1.5 mg/l) and TP (0.1 mg/l) TMDLs are based on literature values, ambient data analysis, and the evaluation of down stream uses (Thornton, 2007).

## 1.4 Selection of a Critical Condition

The critical condition represents the hydrologic and atmospheric conditions in which the pollutants causing impairment of a water body have their greatest potential for adverse effects. The weather data used for this model were collected at several locations in the study area. The representative hydrologic periods used for this modeling project was a wet year, 1995, and a dry year, 1968, as determined by an analysis of mean annual rainfall distributions at several stations including Poplarville, Gulfport, Picayune, and Bay St. Louis.

Critical conditions for waters impaired by nonpoint sources that are runoff related generally occur during periods of wet-weather and high surface runoff. But, critical conditions for nonpoint and point sources that continually discharge generally occur during low-flow, low-dilution conditions. The modeling was done using the wet year and the dry year that were determined to be representative through the evaluation of precipitation records for the period of record of several stations in the area. The dry year has been determined to be the most critical for both TBODu and TN and TP water quality results in these water bodies.

## 1.5 Selection of a TMDL Endpoint

One of the major components of a TMDL is the establishment of instream numeric endpoints, which are used to evaluate the attainment of acceptable water quality. Instream numeric endpoints, therefore, represent the water quality goals that are to be achieved by meeting the load and wasteload allocations specified in the TMDL. The endpoints allow for a comparison between observed instream conditions and conditions that are expected to restore designated uses. The instream DO target for this TMDL is a daily average of not less than 5.0 mg/l. The instantaneous minimum portion of the DO standard was considered when establishing the instream target for this TMDL. However, it was determined that using the daily average standard with the conservative modeling assumptions would protect the instantaneous minimum standard. Based on the limited data available for calibration and the capability of the model, the daily average target is appropriate.

The TMDL for DO will be quantified in terms of organic enrichment. Organic enrichment is measured in terms of total ultimate biochemical oxygen demand (TBODu). TBODu represents the oxygen consumed by microorganisms while stabilizing or degrading carbonaceous and nitrogenous compounds under aerobic conditions over an extended time period. The carbonaceous compounds are referred to as CBODu, and the nitrogenous compounds are referred to as NBODu. TBODu is equal to the sum of NBODu and CBODu, Equation 1.

$$\text{TBODu} = \text{CBODu} + \text{NBODu} \quad (\text{Equation 1})$$

There are no state criteria in Mississippi for nutrients. These criteria are currently being developed by the Mississippi Nutrient Task Force in coordination with EPA Region 4. MDEQ proposed a work plan for nutrient criteria development that has been approved by EPA and is on schedule according to the approved plan in development of nutrient criteria (MDEQ, 2004).

For this TMDL, MDEQ is presenting preliminary target concentrations for TN and TP. A concentration of 1.5 mg/l is an applicable target for TN and 0.1 mg/l is an applicable target for TP for the tributaries to St. Louis Bay. However, MDEQ is presenting these concentrations as preliminary target values for TMDL development which are subject to revision after the development of nutrient criteria, when the work of the NTF is complete.

# WATER BODY ASSESSMENT

This TMDL report includes an analysis of available water quality data and the identification of all known potential pollutant sources in the watersheds of the listed tributaries to St. Louis Bay. The potential non-point pollutant sources were characterized by the best available information, monitoring data, and literature values. There are some NPDES permitted point sources in some of the watersheds.

## 2.1 Discussion of Instream Water Quality Data

The listings are all evaluated, and there is only a limited amount of historical data available for the tributaries of St. Louis Bay. Limited chemical data were collected at stations on all of the tributaries as a part of an Ambient Monitoring Program effort in the Coastal Streams Basin in 1998. They were all visited again in 1998 and 1999 as a part of the modeling calibration and verification studies. Additionally, Bayou Portage and Canal Number 3 were visited in 2001 as a part of a Wet-Weather Monitoring Program, which was also conducted to support this modeling effort.

The following summary of water quality impacts from Hurricane Katrina is provided from the MDEQ 2006 Annual Report (MDEQ, 2007). Following Hurricane Katrina, state and federal agencies collaborated to conduct needed monitoring in the affected area. The result was an unprecedented amount of environmental monitoring in the Northern Gulf area. Data is still coming in, but the results to date indicate that despite the devastation, there seems to be very limited, chemical contamination. The primary impacts so far appear to be episodic bacterial contamination, physical damage to habitat such as oyster reefs, and fish kills in the rivers and lakes due to low oxygen. The oxygen depletion was caused by the decaying vegetation and other storm debris that was washed into the streams. The estimated value of the fish killed following Hurricane's Katrina and Rita is \$23.7 million.

## 2.2 Assessment of Nonpoint Sources

The following description of the nonpoint sources of nutrients and organic enriching substances is from the Development of a Comprehensive Water Quality Model of the St. Louis Bay Estuary and Watershed (Huddleston, et. al., 2003).

The majority of the study area, especially the northern and middle portions of the watershed, remains fairly undeveloped. Figure 2 depicts the pre-Katrina land uses within the watershed, and Figure 3 displays that land use distribution. Over half of the land area is covered in forest. The forestland is predominantly pine forests, with bottomland hardwood forests common along the stream banks and near the coast, as well as some deciduous forests interspersed throughout the study area. Typically, forestland poses little risk to surface water quality because forest ecosystems retain nutrients very efficiently (Binkley, 1986). However, activities such as forest fertilization may increase the risk of nutrient loading to nearby streams. Currently, very little, if any forest fertilization occurs

within the study area, but such activity may be planned in the near future in an effort to increase forest growth and harvest.

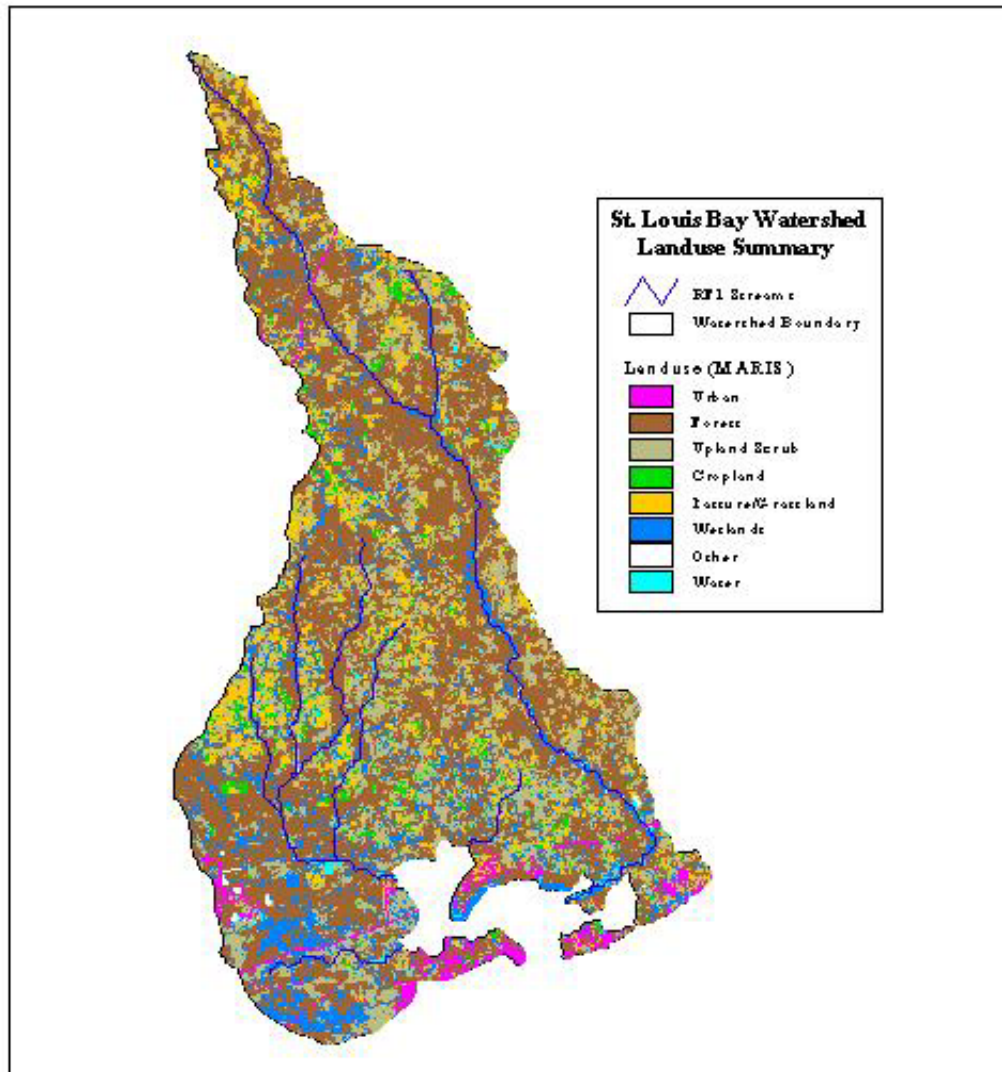
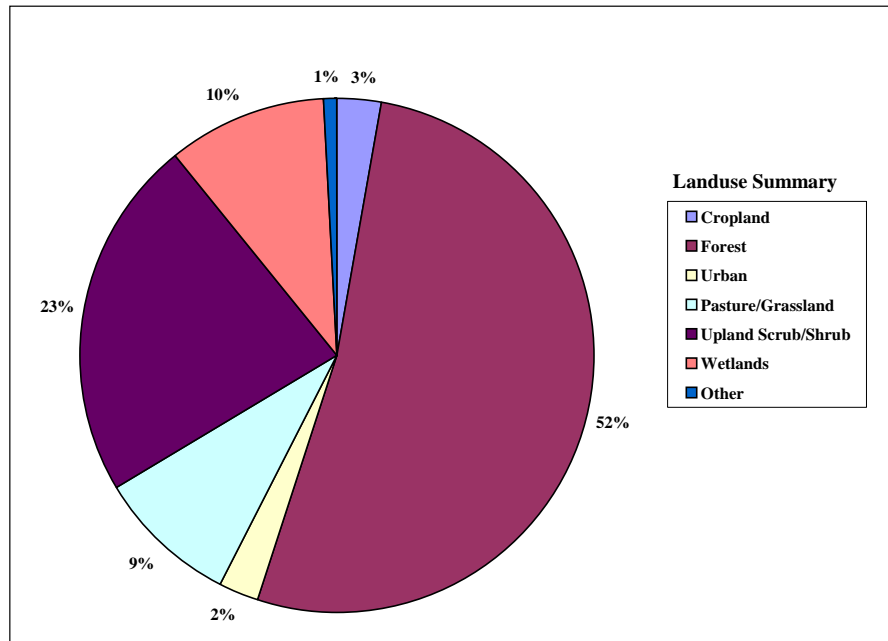

Figure 2. St. Louis Bay Watershed pre-Katrina Land Use Summary (from Huddleston, et. al., 2003)



**Figure 3. St. Louis Bay Watershed pre-Katrina Land Use Distribution (from Huddleston et. al., 2003)**

Timber harvesting is another activity that may increase the nutrient loading from forest runoff. Upland scrub/shrub land, the second most common land use in the watershed, is a result of timber harvesting. Upland scrub/shrub land is a vegetated, non-wetland area that can neither be described as forest or pasture due to the stage of management (MARIS, 2001). This land use category includes forest areas that have recently been harvested and/or replanted, or brush areas consisting of bushes and small trees. The prevalence of upland scrub throughout the study area is due to the extensive forestry industry in the area. Although studies on the effect of timber harvest on nutrient losses have had varied results, clear cutting has been found to cause nitrogen loss from forests (Fredriksen, 1973). The increased nitrogen losses can be due to several factors, including increased rates of decomposition and nutrient release due to warmer and wetter forest floor conditions, reduced nitrogen uptake due to less vegetation, and increased nitrification (Binkley, 1986). The increase in erosion due to timber harvesting can also increase the nutrient loading from rainfall runoff.

Scattered throughout the forest and scrubland are areas of agricultural land. Although cropland comprises less than three percent of the total land area, it remains important in this study because cropland management practices can be a significant source of nutrient loading to nearby waters. Fertilization at excessive rates or careless fertilization of cropland can lead to runoff of nitrogen and phosphorus from the land surface or infiltration of nitrogen into groundwater. The main crop within the study area is hay. Other commonly grown crops include wheat, corn and soybeans (USDA, 2001).

Pasture and grasslands account for nine percent of the land within the study area. Cattle production is the dominant livestock production industry in the area. Moderate annual temperatures allow grazing throughout all seasons. As a result, confinement of cattle within the study area is rare (Pace, 2001). Livestock grazing can pose a risk to water quality when the animals have access to the streams. Increased nutrient loading can occur from livestock defecation in or near the stream, or by destruction of riparian zones along stream banks, which in turn increases erosion.

Although small population centers are scattered throughout the study area, the majority of the urban land use is located in the southern portion of the watershed, along the perimeter of the Bay. Communities such as Bay St. Louis, Pass Christian, and Long Beach are located within the southern portion of the study area, as depicted in Figure 2. Much of the land area along the Bay is also covered by wetlands. However, significant changes have occurred in the area around the Bay since Hurricane Katrina.

Nonpoint sources can contribute to nutrient and oxygen depletion problems within a water body. Nonpoint sources are difficult to quantify and even more difficult to control. Agriculture is generally identified as one of the largest contributors to nonpoint source pollution problems (Howarth et al., 2000). Nitrogen and phosphorus from crop fertilization can reach the streams through rainfall runoff or infiltration into the groundwater. Nutrients from animal waste can also reach the water bodies via rainfall runoff from pastures or from direct input through cattle defecation when grazing along stream banks.

Urban runoff is another nonpoint source of nutrients (USEPA, 1993). Fertilizer application within urban settings such as private lawns, parks, and golf courses, can cause high nutrient levels in urban storm water runoff. Another major cause for nonpoint source nutrient contributions is the failure of septic systems within the study area. Due to the rural nature of the watershed, many people rely on private septic systems for waste treatment. However, the low elevation and soil type throughout the watershed results in failure of many septic systems. Failing septic systems lead to the input of nutrients into water bodies through either direct means or infiltration into the groundwater.

Atmospheric deposition is another source of nutrients to the St. Louis Bay system. It has been found that nitrogen in rain and airborne particles contributes as much as 15 to 35 percent of the nitrogen in coastal streams flowing into U.S. estuaries (USGS, 2000). There are two main forms of atmospheric deposition: wet deposition and dry deposition. Wet deposition occurs when nitrate and ammonium are carried onto land and water surfaces through snow and rainfall. Dry deposition involves the complex interaction of airborne nitrogen compounds with plant, water, soil, rock, or other surfaces (NADP, 2000). Although some nitrogen in the air comes from natural sources, a large portion originates from human sources. In fact, human sources have been found to be accountable for more than 90% of U.S. nitrogen oxide emissions, with the largest sources being vehicle emissions, electric utilities, and industrial boilers (NADP, 2000). Agricultural sources such as fertilizer application and animal waste (urine and manure) account for a large portion of ammonia air emissions.

Extensive work has been completed by the Civil and Environmental Engineering Departments of Mississippi State University and Tennessee Tech University and the Plant and Soil Sciences Department of Mississippi State University to accurately characterize the nonpoint sources described above in this modeling system. Nonpoint source representation in the model are described in more detail in Section 3 as well as in Development of a Comprehensive Water Quality Model of the St. Louis Bay Estuary and Watershed (Huddleston, et. al., 2003) and Refinement and Calibration of the Developed Comprehensive Water Quality Model for St. Louis Bay Estuary (Huddleston, et. al., 2006).

### 2.3 Assessment of Point Sources

An important step in assessing pollutant sources in the St. Louis Bay watershed is locating the NPDES permitted sources. While only one of the five 303(d) segments included in this report has a point source that discharges directly into it, it is a tidally influenced system where the segments may be affected by facilities that are up or down stream. Table 1 provides a list of all of the point sources that discharge into the St. Louis Bay lower watershed.

**Table 1. NPDES Permitted Facilities Treatment Types**

Name	NPDES Permit	Treatment Type
Long Beach Industrial District Park	MS0022373	Activated Sludge
Total Environmental Solutions Inc, Discovery Bay Subdivision	MS0021865	Aerobic Treatment Unit
Hancock County Utility Authority, Waveland POTW	MS0027847	Activated Sludge
Diamondhead Water and Sewer District	MS0046078	Oxidation Ditch
Five Star RV Resort Park, Outfall 001	MS0035131	Aerated Lagoon
Five Star RV Resort Park, Outfall 002	MS0035131	Activated Sludge
Jourdan River Shores Subdivision	MS0022870	Activated Sludge
Harrison County Wastewater and Solid Waste Management Authority, Long Beach and Pass Christian	MS0043141	Oxidation Ditch
DuPont DeLisle Facility	MS0027294	Activated Sludge
Harrison County Utility Authority, Delisle Wastewater Treatment Facility	MS0052574	Oxidation Ditch
Hancock County Schools, East Hancock Elementary School	MS0057070	Septic Tank w/ Sand Filter

The effluent from the facilities was characterized based on all available data including information on its wastewater treatment system, permit limits, and discharge monitoring reports. The permit limits are given in Table 2.

**Table 2. Identified NPDES Permitted Facilities**

<b>Name</b>	<b>NPDES Permit</b>	<b>Permitted Discharge (MGD)</b>	<b>Permitted BOD<sub>5</sub> (mg/l)</b>
Long Beach Industrial District Park	MS0022373	0.6	10
Total Environmental Solutions Inc, Discovery Bay Subdivision	MS0021865	0.001	30
Hancock County Utility Authority, Waveland POTW	MS0027847	4.9	10
Diamondhead Water and Sewer District	MS0046078	2.5	30
Five Star RV Resort Park, Outfall 001	MS0035131	0.008	30
Five Star RV Resort Park, Outfall 002	MS0035131	0.008	30
Jourdan River Shores Subdivision	MS0022870	0.214	30
Harrison County Wastewater and Solid Waste Management Authority, Long Beach and Pass Christian	MS0043141	7.0	10 (May - December) 20 (January - April)
DuPont DeLisle Facility	MS0027294	0.06	30
Harrison County Utility Authority, Delisle Wastewater Treatment Facility	MS0052574	0.8	10
Hancock County Schools, East Hancock Elementary School	MS0057070	0.014	30

# MODELING PROCEDURE: LINKING THE SOURCES TO THE ENDPOINT

Establishing the relationship between the instream water quality target and the source loading is a critical component of TMDL development. It allows for the evaluation of management options that will achieve the desired source load reductions. The link can be established through a range of techniques, from qualitative assumptions based on sound scientific principles to sophisticated modeling techniques. Ideally, the linkage will be supported by monitoring data that allow the TMDL developer to associate certain water body responses to flow and loading conditions. In this section, the selection of the modeling tools, setup, and model application are discussed.

## 3.1 Modeling Framework Selection

The TMDLs for the tributaries to St. Louis Bay were developed using three computer simulation models. The windows implementation of the Hydrologic Simulation Program - Fortran (WinHSPF), which is part of Better Assessment Science Integrating Point and Nonpoint Sources (BASINS 3.0), was used to simulate the water quantity and quality of the runoff from the watershed. The hydrodynamic version of the Environmental Fluid Dynamics Code (EFDC\_Hydro) was used to simulate the movement of water in the estuarine portion of the Bay and its tributaries. Then the Water Analysis Simulation Program (WASP6) was used to simulate the movement and interaction of the pollutants within the water of the Bay and tributaries. The coupled modeling system was developed by the Plant and Soil Sciences Department at Mississippi State University and the Civil and Environmental Engineering Departments at Mississippi State University and Tennessee Tech University. The model calibration and verification are based on water quality studies of the area which were conducted in 1998, 1999, and 2001. Additional details of the model setup and calibration of the modeling system are available in Development of a Comprehensive Water Quality Model of the St. Louis Bay Estuary and Watershed (Huddleston, et. al., 2003) and Refinement and Calibration of the Developed Comprehensive Water Quality Model for St. Louis Bay Estuary (Huddleston, et. al., 2006).

It was determined that the WinHSPF model would be the most suitable option for modeling nutrients and dissolved oxygen within the St. Louis Bay watershed, because in addition to calculating nonpoint source loads from the watershed, WinHSPF can simulate instream processes, allowing the model to estimate the water quality and quantity entering the downstream Bay (for input into an estuary model). The ability of HSPF to model nonpoint sources from mixed land uses is necessary when applying a model to a large, diverse watershed such as the St. Louis Bay study area. Because WinHSPF allows complete access to the functionality of HSPF, the simulation of nutrient loading from agricultural lands will be more representative than if using NPSM. Another positive aspect of HSPF is the continuous simulation, versus steady-state assumptions that some models utilize. Continuous simulation provides a more realistic outlook on hydrology and water quality in a system, allowing seasonal variation to be accounted for. This is especially important when modeling nutrients and dissolved oxygen because of the sensitivity to seasonal fluctuations in temperature and other meteorological inputs. In addition to satisfying the above-mentioned criteria, WinHSPF is available in the public domain and supported by the USEPA. Technical support for WinHSPF is available through the USEPA website and BASINS listserv, as well as documents and web-based assistance included with the installation package.

## 3.2 Model Setup

The watershed stream network is comprised of the mainstream and tributaries of the Wolf and Jourdan Rivers and numerous small bayous. For modeling and analysis purposes, the watershed has been delineated into hydrologically-connected subwatersheds. Figure 4 displays the delineated St. Louis Bay watershed. The delineation of subwatersheds within the Wolf and Jourdan Rivers, Bayou LaCroix, and Rotten Bayou stream systems were based on the RF1 (1:500,000 scale) stream network. Digital elevation model (DEM) data and the RF3 (1:100,000 scale) stream network were used to define the subwatershed boundaries. The remaining land areas surrounding the St. Louis Bay were delineated based on the RF3 stream network. Table 3 shows a summary of the subwatershed identification number (ID), stream name, and drainage area size for each subwatershed. The stream network data was obtained through the USEPA BASINS 3.0 software.



**Table 3. Subwatershed Summary for the St. Louis Bay Study Area**

SUBWATERSHED	SUBWATERSHED ID	STREAM NAME	AREA (ACRES)
03170009018	018	Wolf River	97,171
03170009019	019	Murder Creek	19,756
03170009020	020	Wolf River	77,991
03170009026	026	Bayou Bacon	36,982
03170009027	027	Jourdan River	24,126
03170009028	028	Jourdan River	1,208
03170009029	029	Hickory Creek	32,715
03170009030	030	Catahoula Creek	21,702
03170009031	031	Mill Creek	18,015
03170009032	032	Bayou La Croix	27,853
W6	W6	De Lisle Bayou	4681
W7	W7	Bayou Portage	5272
W8	W8	Johnson Bayou	3773
W9	W9	Bayou Portage	730
W10	W10	Unnamed Bayou/Bayou Portage	553
W11	W11	Young Bayou/Bayou Portage	754
W12	W12	Mallini Bayou	908
W13	W13	Unnamed Bayou/Bayou Portage	666
W14	W14	Unnamed Bayou /De Lisle Bayou	1390
W15	W15	Unnamed Bayou/St. Louis Bay	309
W16	W16	Unnamed Bayou/St. Louis Bay	1700
W17	W17	Unnamed Bayou/St. Louis Bay	629
W18	W18	Unnamed Bayou/St. Louis Bay	1047
W19	W19	Cutoff Bayou/St. Louis Bay	3192
W20	W20	Rotten Bayou	18691
W21	W21	Bayou La Terre	15462
W22	W22	Bayou Coco	1499
W23	W23	Bayou Talla	6096
W25	W25	Unnamed Bayou/Jourdan River	4075
W26	W26	Bayou Marone	5781
W27	W27	Bayou Philip	13423
W28	W28	Four Dollar Bayou	1256
W29	W29	Breath Bayou	1466
W30	W30	Edwards Bayou	1140
W31	W31	Watts Bayou	1268
W32	W32	Joes Bayou	907
W33	W33	Unnamed Bayou/St. Louis Bay	765

The computational domain for the model set up of the Bay and estuarine area was taken from the previous study for Fecal Coliform TMDL (Huddleston et al., 2001). The model domain, as shown in Figure 5, defines the primary bay area as well as inlets from major surrounding tributaries that provide fresh water inflow into the bay. As an illustration, the Wolf River and

Jourdan River domain extends approximately ten miles upstream, where the tidal effect has become negligible. Such treatment decouples the estuary model from the upstream watershed model so that the inflow conditions for the estuary model at these two river boundaries can be obtained from the independent watershed model results. At the southern side, an open boundary is assigned near the bay mouth where the bay connects to the Mississippi Sound.

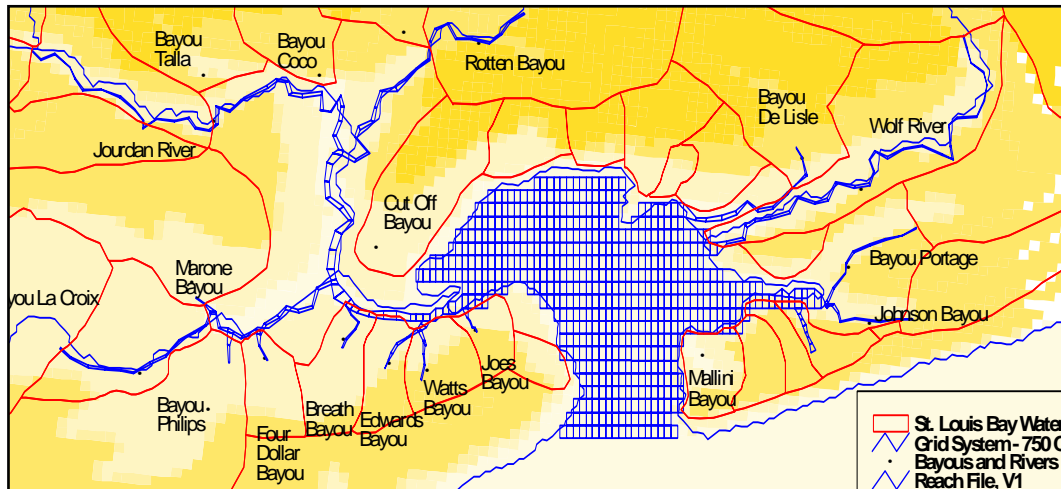

Figure 5. St. Louis Bay modeling domain and segmentation (from Huddleston, et. al., 2003)

The horizontal grid system, also shown in Figure 5, consists of a Cartesian sub-grid for the bay area and two boundary-fitting curvilinear sub-grids for the Jourdan and Wolf tributary network respectively. The curvilinear sub-grids were generated using a program called GEFDC, a grid-generation pre-processor for the EFDC model. 750 active cells were used to define each layer of the computational domain. The vertical discretization in EFDC is based on the terrain-following  $\sigma$  coordinate using two equally divided vertical layers.

### 3.3 Source Representation

The following modeling descriptions are from Development of a Comprehensive Water Quality Model of the St. Louis Bay Estuary and Watershed (Huddleston, et. al., 2003). Within HSPF, there are two main modules used to simulate nonpoint source loading to streams: PERLND and IMPLND. These modules are used to describe hydrologic, sediment and water quality processes on the land surface and through subsurface pathways (Bicknell et al, 2000). Because HSPF offers versatility in the methods used to simulate the hydrology and water quality of nonpoint source runoff within a watershed, a combination of methods was applied to this study. To simulate the dissolved oxygen in the runoff, PWTGAS and IWTGAS were utilized. Simulation of nutrients was performed using the simplified PQUAL for all land uses except the cropland. The agricultural sections were utilized to represent the nutrient cycling processes for the four cropland land use categories: hay cropland, soybean cropland, wheat cropland, and corn cropland. The SEDMNT section of the PERLND module that simulates erosion processes was also utilized on cropland areas since nutrients are often transferred to surface water through adsorption to sediment.

The nutrient processes simulated in the St. Louis Bay watershed model include adsorption, desorption, mineralization, immobilization, nitrification, denitrification, and plant uptake. These

processes are simulated in the NITR and PHOS sections of the PERLND module. The nutrient constituents that were modeled include nitrate ( $\text{NO}_3$ ), ammonium ( $\text{NH}_3$ ), organic nitrogen, orthophosphate ( $\text{PO}_4$ ), and organic phosphate. Nitrate ( $\text{NO}_2$ ) was not separately considered since the transformation from  $\text{NO}_2$  to  $\text{NO}_3$  is very rapid in most agricultural soils (Donigian et al., 1994).

The nonpoint source simulation of nutrient loading and oxygen demand from non-cropland land areas was conducted using a more simplified approach compared to the cropland simulation. The simplified approach, which simulates each water quality constituent independently based on simple relationships with water and/or sediment, was selected for the non-cropland land areas because adequate data was not available for use of the more advanced agri-chemical sections of HSPF that model nutrient cycling. The PQUAL and IQUAL sections of HSPF, for pervious land and impervious land, respectively, were employed to model the loading from non-cropland land areas for the following constituents: ammonia ( $\text{NH}_4$ ), nitrate ( $\text{NO}_3$ ), organic nitrogen, orthophosphate ( $\text{PO}_4$ ), organic phosphorus, and biochemical oxygen demand (BOD). The basic algorithms used in the PQUAL and IQUAL sections of HSPF to simulate water quality constituents are a combination of methods from previous models such as the NPS Model (Donigian and Crawford, 1976) and HSP Quality (Hydrocomp, 1977).

In WASP6 two kinetic sub-models are provided to simulate two of the major classes of water quality problems. The EUTRO sub-model solves conventional pollution involving dissolved oxygen, biochemical oxygen demand, nutrients and eutrophication, while the TOXI sub-model solves toxic pollution involving organic chemicals, metals, and sediment. To apply the WASP6, unsteady flow hydrodynamics, turbulent exchange, and model segmentation must be prescribed externally. In this study, these data are extracted from the EFDC\_hydro hydrodynamic simulation output.

To simulate nutrient kinetic processes eight major water quality state variables are computed in the EUTRO sub-model of WASP6. These include Ammonia, Nitrite, Orthophosphate, Chlorophyll a, BOD, Dissolved Oxygen, Organic Nitrite, and Organic Phosphate. Figure 6 depicts the schematic interactive relationship among those variables modeled within WASP6-EUTRO that reflects four interacting systems: phytoplankton kinetics, the phosphorus cycle, the nitrogen cycle, and the dissolved oxygen balance. Various formulations and parameterizations describing these kinetic relationships have been studied and developed based on statistical analysis of lab data and field data. The WASP6 User's Manual provides more detailed information on the model formulations as well as some guidelines toward the specification of model parameters.

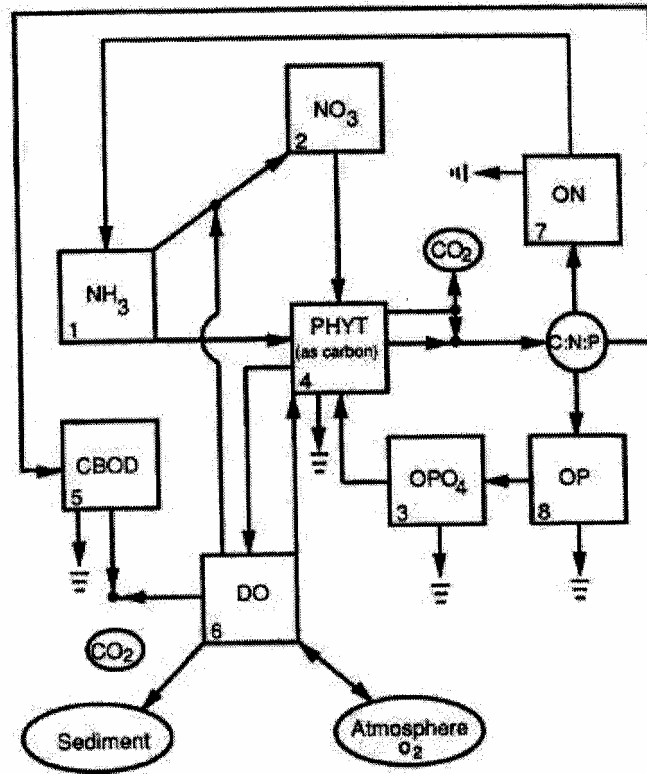

Figure 6. State variable interactions in the nutrient dynamics model (from Huddleston, et. al., 2003)

Both point and non-point sources were represented in the Bay model. The loads from the NPDES permitted sources were added as direct inputs into the appropriate cells. However, there are not any point sources that discharge directly into either of the two segments listed for OE/low DO, Bayou LaCroix or Rotten Bayou. Background and boundary concentrations were based on study data and watershed model output and are shown in Table 4.

Table 4. Boundary conditions for the Bay Model (From Huddleston, et. al., 2007)

Loading Sources	DO	BOD	NH3	NO3	PO4	ON	OP
Small watershed sources	7	7	0.06	0.03	0.05	0.2	0.15
Open sea boundary	8	4	0.06	0.04	0.03	0.17	0.06

### 3.4 Model Calibration

The Refinement and Calibration of the Developed Comprehensive Water Quality Model for St. Louis Bay Estuary (Huddleston, et. al., 2006) was completed subsequent to the initial project to include the integration of more extensive data, primarily to describe agricultural practices, into the watershed model and general model refinement and extension. The primary enhancements were associated with improved assessment of site-specific properties and practices. Extensive laboratory analysis of field samples and the impact upon key model parameters and techniques were described. Significant improvement in correlation of the simulation results with field data and the model modifications that generated the improvement is reported.

The computed water quality time series from the calibrated watershed model were then set up as the boundary condition of the bay water quality model, WASP. Based on the results of sensitivity analysis, the constant parameters were classified and 4 modeling scenarios were proposed to improve the fitting between simulated and measured data. However, it must be indicated that the measured data is so limited, available only for three days, to reflect the annual and seasonal trend of water quality constituent. More extensive data were needed for the purpose of extensive model calibration. The improved and refined model was used for the development of these TMDLs.

### 3.5 Model Results for DO and BOD

Once the model setup was complete, the model was used to predict water quality conditions in the listed tributaries of St. Louis Bay. Only Bayou LaCroix and Rotten Bayou are listed for organic enrichment and low DO. The model was first run under regulatory load conditions. Under these conditions, the load from the NPDES permitted point sources were set at the current location and maximum permit limits as shown in Table 2. While none of these point sources discharge directly into the listed Bayou LaCroix or Rotten Bayou segments, the permit information is provided because this is tidally influenced system.

#### 3.5.1 Regulatory Load Scenario

The regulatory load scenario model results are shown in Figures 7 and 8 for Bayou LaCroix and Rotten Bayou, respectively. Figures 7 and 8 show the modeled daily average DO in Bayou LaCroix and Rotten Bayou with the NPDES permits at maximum allowable loads and with estimated non-point source loads (Huddleston, et. al., 2007). The figures show the daily average instream DO concentrations in the segment for the critical period modeled. As shown in the figures, the model does not predict that the DO goes below the standard of 5.0 mg/l using the maximum allowable loads.

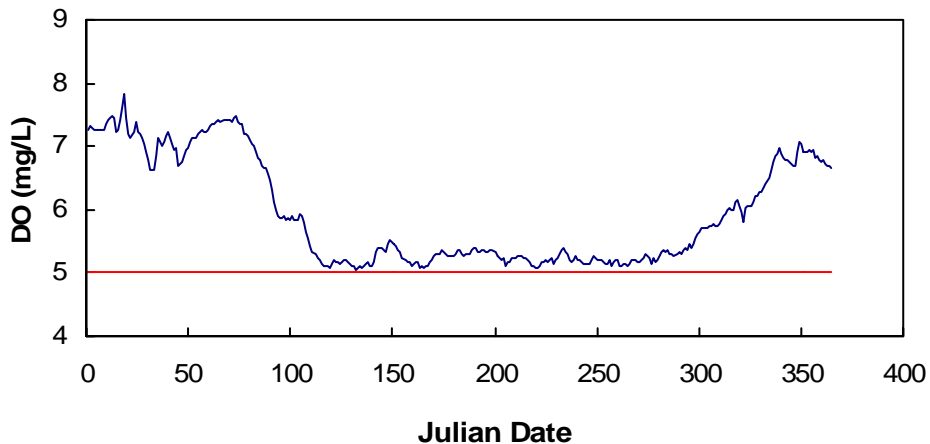

Figure 7. Model Output for DO in Bayou LaCroix, Regulatory Load Scenario

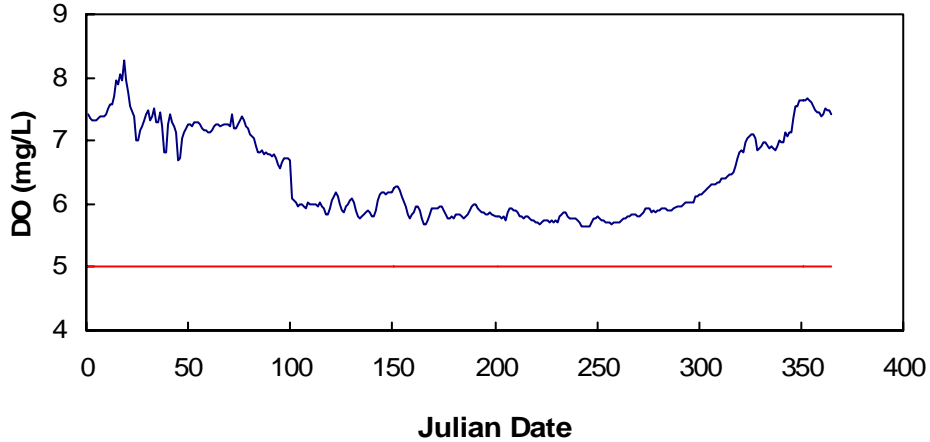

Figure 8. Model Output for DO in Rotten Bayou, Regulatory Load Scenario

### 3.5.2 Maximum Load Scenario

The graphs of the regulatory load scenario output shows that the predicted DO does not fall below the DO standard in Bayou LaCroix or Rotten Bayou during critical conditions. Thus, reductions from the loads of TBODu are not necessary. Calculating the maximum allowable load of TBODu involved increasing the non-point source loads only and running the model using a trial-and-error process until the modeled DO was just above 5.0 mg/l. The non-point source loads were increased by a factor of 1.26 for Bayou LaCroix and 4.86 for Rotten Bayou in this process. The increased loads were used to develop the allowable maximum daily load for this report. The model output for DO with the increased loads is shown in Figures 9 and 10.

Figures 9 and 10 show the modeled instream DO concentrations in Bayou LaCroix and Rotten Bayou after application of the selected maximum load scenario at critical conditions (Huddleston, et. al., 2007). The model results for the maximum load scenario show that the water body does have additional assimilative capacity.

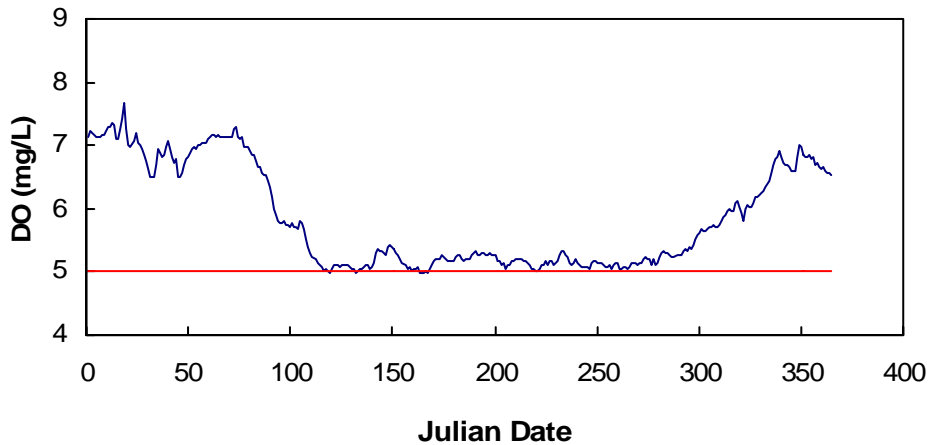

Figure 9. Model Output for Bayou LaCroix for DO, Maximum Load Scenario

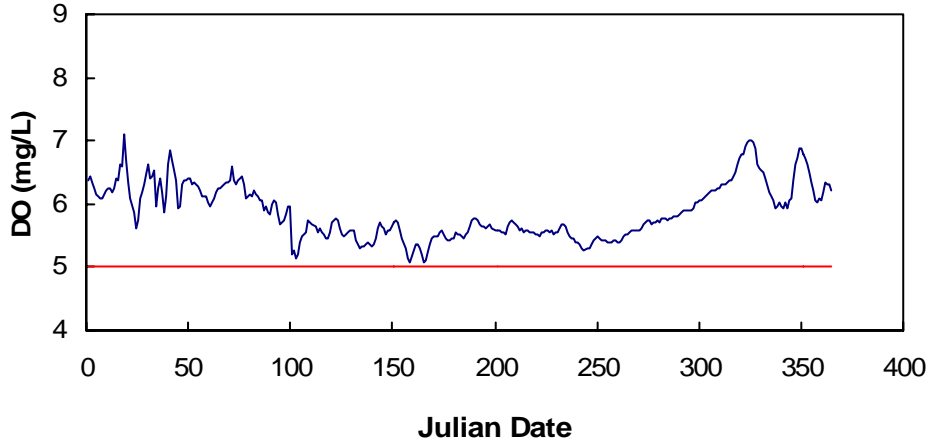

Figure 10. Model Output for Rotten Bayou for DO, Maximum Load Scenario

### 3.6 Estimated Existing Load for Nutrients

The estimated existing total nitrogen concentration is based on the modeling results in three of the listed segments, Bayou LaCroix, Canal Number 3, and Rotten Bayou, which are shown in figures 11, 12, and 13 (Huddleston, et. al., 2007). The other two segments included in this TMDL, Cutoff Bayou and Mallini Bayou, are not specifically represented as cells in the model. Therefore, no model output is available for those. However, flows and concentrations used in the model provided estimates of the existing TN loads in those two water bodies. Due to the lack of useable data for calibration the model results for total phosphorous are not utilized in this TMDL to present the estimated existing concentrations. However, TP targets are presented in Section 5.

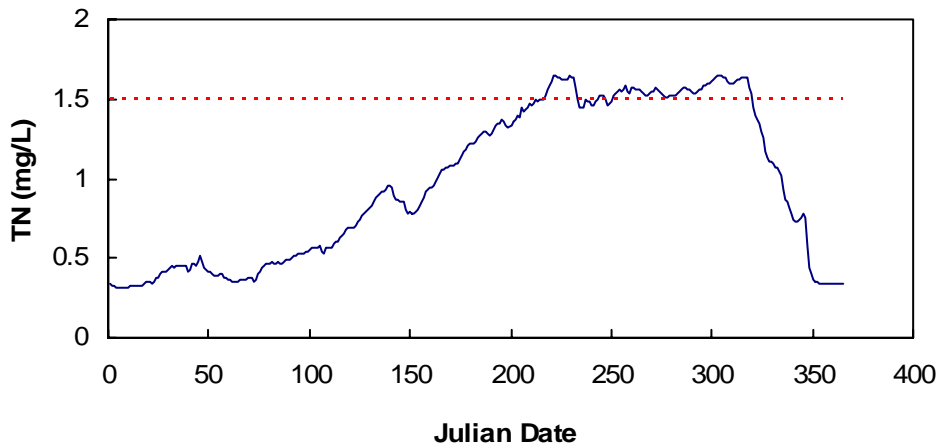

Figure 11. Simulated TN concentrations in Bayou La Croix under critical conditions

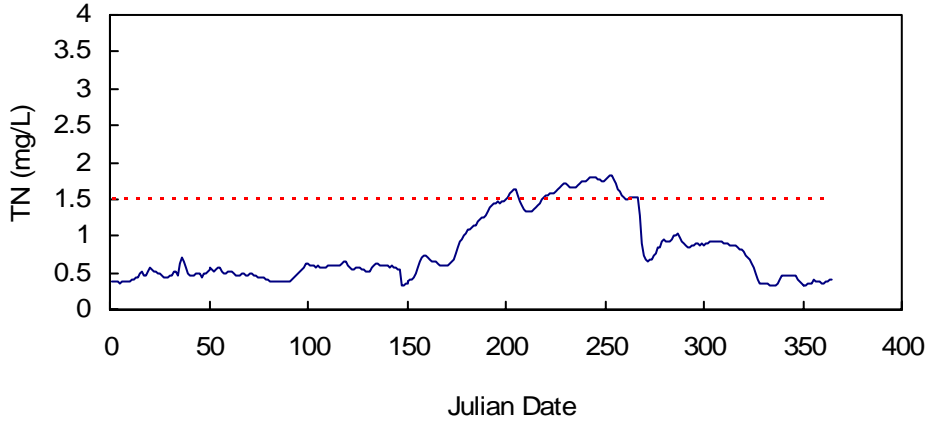

Figure 12. Simulated TN concentrations in Canal Number 3 under critical conditions

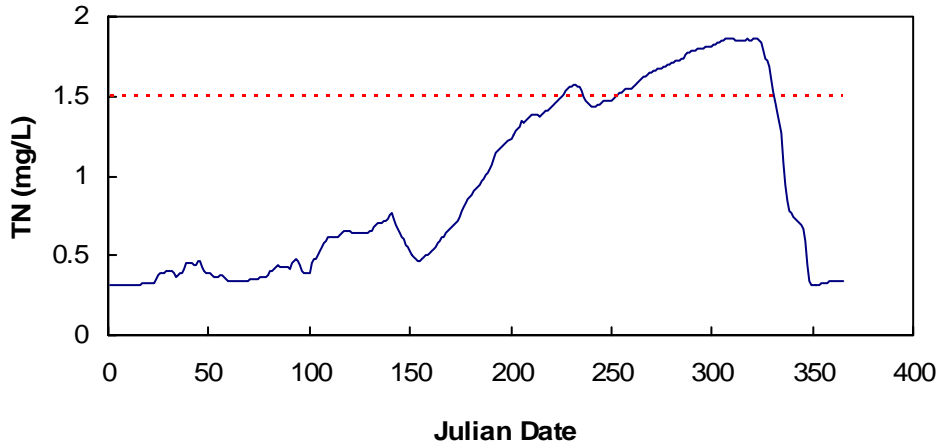

Figure 13. Simulated TN concentrations in Rotten Bayou under critical conditions

To convert the simulated existing total nitrogen concentrations to a total nitrogen load for the modeled segments, the maximum concentration during the critical period was multiplied by the flow in that segment. The results are shown in Table 5 (Huddleston, et. al., 2007). For Bayou LaCroix the estimated existing TN load is 8,658 lb/day. For Canal Number 3 the estimated existing TN load is 868 lb/day. For Rotten Bayou the estimated existing TN load is 7,205 lb/day.

Table 5. Estimated Existing Total Nitrogen Loads for modeled tributaries to St. Louis Bay

Segment	Flow (m <sup>3</sup> /day)	TN (mg/L)	TN (lbs/day)
Bayou LaCroix	2,379,744	1.65	8,658
Canal Number 3	216,180	1.82	868
Rotten Bayou	1,756,722	1.86	7,205

For the other two water bodies, Cutoff Bayou and Mallini Bayou, the estimated existing TN loads are based on the maximum flow and concentration from that segment. The results are presented in Table 6.

**Table 6. Estimated Existing Total Nitrogen Loads for other tributaries to St. Louis Bay**

Segment	Flow (m <sup>3</sup> /day)	TN (mg/L)	TN (lbs/day)
Cutoff Bayou	501,111	0.29	320
Mallini Bayou	144,452	0.29	92

The TN point source load is estimated to be 1,826.7 lbs/day into the Bay as shown in Table 7. However, none of these facilities discharges directly into a segment listed for nutrients. Therefore, the total load is from nonpoint sources, but all of the point sources in the area are provided for information.

**Table 7. NPDES Permitted Facilities Treatment Types with Nitrogen Estimates**

Facility Name	NPDES	Treatment Type	Permitted Discharge (MGD)	TN Conc estimate (mg/l)	TN Load estimate (lbs/day)
Long Beach Industrial District Park	MS0022373	Activated Sludge	0.6	13.6	68.1
Total Environmental Solutions Inc, Discovery Bay Subdivision	MS0021865	Aerobic Treatment Unit	0.001	11.5	0.1
Hancock County Utility Authority, Waveland POTW	MS0027847	Activated Sludge	4.9	13.6	555.8
Diamondhead Water and Sewer District	MS0046078	Oxidation Ditch	2.5	13.6	283.6
Five Star RV Resort Park, Outfall 001	MS0035131	Aerated Lagoon	0.008	11.5	0.8
Five Star RV Resort Park, Outfall 002	MS0035131	Activated Sludge	0.008	13.6	0.9
Jourdan River Shores Subdivision	MS0022870	Activated Sludge	0.214	13.6	24.3
Harrison County Wastewater and Solid Waste Management Authority, Long Beach and Pass Christian	MS0043141	Oxidation Ditch	7.0	13.6	794.0
DuPont DeLisle Facility	MS0027294	Activated Sludge	0.06	13.6	6.8
Harrison County Utility Authority, Delisle Wastewater Treatment Facility	MS0052574	Oxidation Ditch	0.8	13.6	90.7
Hancock County Schools, East Hancock Elementary School	MS0057070	Septic Tank w/ Sand Filter	0.014	13.6	1.6
		<b>Total</b>	<b>16.1</b>		<b>1,826.7</b>

The TP point source load is estimated to be 706.4 lbs/day into the Bay as shown in Table 8. However, none of these facilities discharges directly into a segment listed for nutrients. Therefore, the total load is from nonpoint sources, but all of the point sources in the area are provided for information.

**Table 8. NPDES Permitted Facilities Treatment Types with Phosphorus Estimates**

Facility Name	NPDES	Treatment Type	Permitted Discharge (MGD)	TP Conc estimate (mg/l)	TP Load estimate (lbs/day)
Long Beach Industrial District Park	MS0022373	Activated Sludge	0.6	5.8	29.0
Total Environmental Solutions Inc, Discovery Bay Subdivision	MS0021865	Aerobic Treatment Unit	0.001	5.2	0.04
Hancock County Utility Authority, Waveland POTW	MS0027847	Activated Sludge	4.9	5.8	237.0
Diamondhead Water and Sewer District	MS0046078	Oxidation Ditch	2.5	5.8	48.4
Five Star RV Resort Park, Outfall 001	MS0035131	Aerated Lagoon	0.008	5.2	0.3
Five Star RV Resort Park, Outfall 002	MS0035131	Activated Sludge	0.008	5.8	0.4
Jourdan River Shores Subdivision	MS0022870	Activated Sludge	0.214	5.8	10.4
Harrison County Wastewater and Solid Waste Management Authority, Long Beach and Pass Christian	MS0043141	Oxidation Ditch	7.0	5.8	338.6
DuPont DeLisle Facility	MS0027294	Activated Sludge	0.06	5.8	2.9
Harrison County Utility Authority, Delisle Wastewater Treatment Facility	MS0052574	Oxidation Ditch	0.8	5.8	38.7
Hancock County Schools, East Hancock Elementary School	MS0057070	Septic Tank w/ Sand Filter	0.014	5.8	0.7
		<b>Total</b>	<b>16.1</b>		<b>706.4</b>

## ALLOCATION

The allocation for this TMDL involves a wasteload allocation (WLA) for point sources, a load allocation (LA) for non-point sources, and an implicit margin of safety (MOS), which will result in attainment of water quality standards in the tributaries to St. Louis Bay. The wasteload allocations specified in this TMDL are currently zero for the listed tributaries because there are not currently any point sources that discharge directly into the listed segments. At the current BOD loads, water quality standards are attained in the two segments listed for OE/low DO and there is assimilative capacity available for future growth. However, reductions are recommended for the nonpoint sources of nutrients.

### 4.1 Wasteload Allocation

Federal regulations require that effluent limits developed to protect water quality criteria are consistent with the assumptions and requirements of any available wasteload allocation prepared by the state and approved by EPA. The contribution of load from point sources was included in the St. Louis Bay model used for this study based on the facilities' current NPDES permit limits and available discharge monitoring data. However, no facilities currently discharge directly into any of the listed segments. The waste load allocation for the segments listed for OE/low DO is currently zero. At the current BOD loads, water quality standards are attained in the two segments listed for OE/low DO and there is assimilative capacity available for future growth. Future permits will be considered in accordance with Mississippi's *Wastewater Regulations for National Pollutant Discharge Elimination System (NPDES) Permits, Underground Injection Control (UIC) Permits, State Permits, Water Quality Based Effluent Limitations and Water Quality Certification*. Because the nutrient estimates are based on literature values, this TMDL recommends nutrient monitoring for all of the facilities in the Bay area shown in Table 2.

### 4.2 Load Allocation

The watershed TBODu loads from the HSPF model are included in the load allocation for Bayou LaCroix and Rotten Bayou. This TMDL does not require a reduction of the TBODu load allocation. In Table 9, the load allocation is shown as the non-point sources.

**Table 9. TBODu Load Allocation, Maximum Scenario**

	<b>TBODu (lbs/day)</b>
Bayou LaCroix	786
Rotten Bayou	3,259

Based on initial estimates in Section 3.6, the TN and TP loads in this watershed come from non-point sources, which are presented in Table 10. Therefore, best management practices (BMPs) should be encouraged in the watershed to reduce potential nutrient loads from non-point sources. The watershed should be considered a priority for riparian buffer zone restoration and any nutrient reduction BMPs. For land disturbing activities related to silviculture, construction, and agriculture, it is recommended that practices, as outlined in "Mississippi's BMPs: Best Management Practices for Forestry in Mississippi" (MFC, 2000), "Planning and Design Manual for the Control of Erosion, Sediment, and Stormwater" (MDEQ, et. al, 1994), and "Field Office

Technical Guide” (NRCS, 2000), be followed, respectively. Table 10 also shows the load allocation for TN and TP, which are based on the TMDL target values.

**Table 10. Load Allocation for Estimated TN and TP**

Water Body	Nutrient	Estimated Existing Nutrient Nonpoint Source Load (lbs/day)	Allocated Nutrient Nonpoint Source Load (lbs/day)
Bayou LaCroix	TN	8,658	7,871
	TP	NA	525
Canal Number 3	TN	868	715
	TP	NA	48
Rotten Bayou	TN	7,205	5,810
	TP	NA	387
Cutoff Bayou	TN	320	320
	TP	NA	110
Mallini Bayou	TN	92	92
	TP	NA	32

### 4.3 Incorporation of a Margin of Safety

The margin of safety is a required component of a TMDL and accounts for the uncertainty about the relationship between pollutant loads and the quality of the receiving water body. The two types of MOS development are to implicitly incorporate the MOS using conservative model assumptions or to explicitly specify a portion of the total TMDL as the MOS. The MOS for this TMDL is both implicit and explicit.

Conservative assumptions which place a higher demand of DO on the water body than may actually be present are considered part of the implicit margin of safety. The explicit MOS for this report is the difference between the non-point loads calculated in the maximum load scenario and the regulatory load scenario non-point loads. The regulatory load scenario non-point source loads represent an approximation of the loads currently going into Bayou LaCroix and Rottern Bayou at the critical conditions. The maximum non-point source loads are the maximum TBODu loads with a 1.26 increase for Bayou LaCroix and a 4.86 increase for Rotten Bayou that allow maintenance of water quality standards. MDEQ has set the explicit MOS as the difference in these loads. The calculated MOS is in Table 11.

**Table 11. Calculation of Explicit MOS for TBODu in lbs/day**

Water Body	Maximum Non-Point Load	Regulatory Non-Point Load	Margin of Safety
Bayou LaCroix	786	626	160
Rotten Bayou	3,259	671	2,588

### 4.4 Seasonality

The NPSM model was run for a representative dry year, and took into account all of the seasons within the calendar year. This time period allowed the simulation of many different atmospheric conditions such as rainy and dry periods and high and low temperatures. It also allowed seasonal critical conditions to be simulated.

## 4.5 Calculation of the TMDL

The TMDL for TBODu was calculated based on the current loading of pollutant in Bayou LaCroix and Rotten Bayou, according to the model. The TBODu TMDL calculations are shown in Table 12. The wasteload allocations are zero for these segments because there are not any facilities that currently discharge directly into them. The load allocations include the background and non-point sources of TBODu from surface runoff and groundwater infiltration. The implicit margin of safety for this TMDL is derived from the conservative assumptions used in setting up the model, while the explicit margin of safety is calculated based on the maximum loads scenario explained in Section 3.5.2.

The target concentration ranges for TN and TP, presented in Section 1.5 were used with the critical flow for the watershed to determine the TMDLs. The TMDLs, given in Table 13, were then compared to the estimated existing load for TN, presented in Section 3.6. The estimated existing TN concentration indicates needed reductions of 9% to 19%.

**Table 12. TMDL for TBODu in Bayou LaCroix and Rotten Bayou**

	<b>WLA (lbs/day)</b>	<b>LA (lbs/day)</b>	<b>MOS (lbs/day)</b>	<b>TMDL (lbs/day)</b>
Bayou LaCroix	0	626	160	786
Rotten Bayou	0	671	2,588	3,259

**Table 13. TMDLs for Nutrients in the tributaries to St. Louis Bay**

		<b>WLA (lbs/day)</b>	<b>LA (lbs/day)</b>	<b>MOS (lbs/day)</b>	<b>TMDL (lbs/day)</b>
Bayou LaCroix	<b>TN</b>	0	7,871	Implicit	7,871
	<b>TP</b>	0	525	Implicit	525
Canal Number 3	<b>TN</b>	0	715	Implicit	715
	<b>TP</b>	0	48	Implicit	48
Rotten Bayou	<b>TN</b>	0	5,810	Implicit	5,810
	<b>TP</b>	0	387	Implicit	387
Cutoff Bayou	<b>TN</b>	0	320	Implicit	320
	<b>TP</b>	0	110	Implicit	110
Mallini Bayou	<b>TN</b>	0	92	Implicit	92
	<b>TP</b>	0	32	Implicit	32

The TMDLs presented in this report represent the current load of a pollutant allowed in the water body. Although it has been developed for critical conditions in the water body, the allowable load is not tied to any particular combination of point and non-point source loads. The LA given in the TMDL applies to all non-point sources, and does not assign loads to specific sources.

## 4.6 Reasonable Assurance

This component of the TMDL development does not apply to this TMDL Report. There are no point sources (WLA) requesting a reduction based on promised LA components and reductions.

## CONCLUSION

This TMDL is based on a calibrated, dynamic modeling system using field data and extensive research from MSU and TTU. The model results indicate that Bayou LaCroix and Rotten Bayou are meeting the water quality standard for dissolved oxygen at the present loading of TBODu. Thus, this TMDL does not limit the issuance of new permits in the watershed as long as new facilities do not cause impairment in these water bodies.

Nutrients were also addressed through the modeling system. Based on the estimated existing and target TN concentrations, this TMDL recommends a 9% - 19% reduction of the TN loads entering these streams to meet the preliminary target of 1.5 mg/l. Because none of the existing TN load is estimated to be due to point sources, this TMDL does not recommend percent reductions from the NPDES permits. It does recommend quarterly monitoring for all of the facilities that discharge in the Bay area listed in Table 2. It is also recommended that the St. Louis Bay Watershed be considered as a priority watershed for riparian buffer zone restoration and any nutrient reduction BMPs. The implementation of these BMP activities should reduce the nutrient load entering the creeks. This will provide improved water quality for the support of aquatic life in the water bodies and will result in the attainment of the applicable water quality standards.

### 5.1 Public Participation

This TMDL will be published for a 30-day public notice. During this time, the public will be notified by publication in the statewide newspaper. The public will be given an opportunity to review the TMDL and submit comments. MDEQ also distributes all TMDLs at the beginning of the public notice to those members of the public who have requested to be included on a TMDL mailing list. TMDL mailing list members may request to receive the TMDL reports through either, email or the postal service. Anyone wishing to become a member of the TMDL mailing list should contact Kay Whittington at (601) 961-5729 or [Kay\\_Whittington@deq.state.ms.us](mailto:Kay_Whittington@deq.state.ms.us).

At the end of the 30-day period, MDEQ will determine the level of interest in the TMDL and make a decision on the necessity of holding a public hearing. If a public hearing is deemed appropriate, the public will be given a 30-day notice of the hearing to be held at a location near the watershed. That public hearing would be an official hearing of the Mississippi Commission on Environmental Quality, and would be transcribed.

All comments should be directed in writing to Kay Whittington at [Kay\\_Whittington@deq.state.ms.us](mailto:Kay_Whittington@deq.state.ms.us) or Kay Whittington, MDEQ, PO Box 10385, Jackson, MS 39289. All comments received during the public notice period and at any public hearings become a part of the record of this TMDL and will be considered in the submission of this TMDL to EPA Region 4 for final approval.

## REFERENCES

- Bicknell, B.R., John C. Imhoff, John L. Kittle, Jr., Thomas H. Jobes, and Anthony S. Donigian, Jr. 2000. *Hydrological Simulation Program- Fortran User's Manual for Release 12*. U.S. Environmental Protection Agency.
- Binkley, Dan. 1986. *Forest Nutrition Management*. New York: John Wiley & Sons, Inc.
- Donigian, Anthony S. Jr., Brian R. Bicknell, Avinash S. Patwardham, Lewis C. Linker, and Chao-Hsi Chang. 1994. *Chesapeake Bay Program: Watershed Model Application to Calculate Bay Nutrient Loadings*. U.S. Environmental Protection Agency, Chesapeake Bay Program Office. Annapolis, MD.
- Donigian, Anthony S. Jr. and N. H. Crawford. 1976. *Modeling Nonpoint Pollution from the Land Surface*. U.S. Environmental Protection Agency, Technology Development and Applications Branch. Athens, GA.
- Fredriksen, R.L., D.G. Moore, and L.A. Norris. 1975. *The Impact of Timber Harvest, Fertilization, and Herbicide Treatment on Streamwater Quality in Western Oregon and Washington*. Proc. of the Fourth North American Forest Soils Conference, Aug. 1973, Laval University. Quebec: Les Presses De L'Universite Laval.
- Howarth, Robert, Donald Anderson, James Cloern, Chris Elfring, Charles Hopkinson, Brian Lapointe, Tom Malone, Nancy Marcus, Karen McGlathery, Andrew Sharpley, and Dan Walker. 2000. *Nutrient Pollution of Coastal Rivers, Bays, and Seas: Issues in Ecology Number 7*. Ecological Society of America.
- Huddleston, D. H., Z. Liu, W. L. Kingery, and F. Hossain. 2007. *Application of St. Louis Bay Water Quality Model to Develop TMDLs for Tributaries*. Department of Civil and Environmental Engineering, Tennessee Technological University and Department of Plant and Soil Sciences, Mississippi State University.
- Huddleston, D. H., W. L. Kingery, and Zhijun Liu. 2006. *Refinement and Calibration of the Developed Comprehensive Water Quality Model for St. Louis Bay Estuary*. Department of Civil and Environmental Engineering, Tennessee Technological University and Department of Plant and Soil Sciences, Mississippi State University.
- Huddleston, D. H., W. L. Kingery, J. M. Kieffer, V. Alacron, and W. Chen. 2003. *Development of a Comprehensive Water Quality Model of the St. Louis Bay Estuary and Watershed*. Department of Civil Engineering, Mississippi State University.
- Huddleston, D. H., A. Shindala, V. L. Zitta, and N. B. Hashim. 2001. *Mathematical Modeling for Development of Total Maximum Daily Load (TMDL) for Fecal Coliform Bacteria in the St. Louis Bay Watershed*. Mississippi State University.
- Hydrocomp, Inc. 1977. *Hydrocomp Water Quality Operations Manual*. Palo Alto, CA.

- Mississippi Automated Resource Information System (MARIS). 2001. *Mississippi Land Use/Land Cover Project Metadata*.
- MDEQ. 2007. *Mississippi Department of Environmental Quality Annual Report 2006*.
- MDEQ. 2004. *Mississippi's Plan for Nutrient Criteria Development*. Office of Pollution Control.
- MDEQ. 2002. *State of Mississippi Water Quality Criteria for Intrastate, Interstate, and Coastal Waters*. Office of Pollution Control.
- MDEQ. 1998. *Mississippi 1998 Water Quality Assessment, Pursuant to Section 305(b) of the Clean Water Act*. Office of Pollution Control.
- MDEQ, MSWCC, and USDA SCS. 1994. *Planning and Design Manual for the Control of Erosion, Sediment, and Stormwater*.
- MDEQ. 1994. *Wastewater Regulations for National Pollutant Discharge Elimination System (NPDES) Permits, Underground Injection Control (UIC) Permits, State Permits, Water Quality Based Effluent Limitations and Water Quality Certification*. Office of Pollution Control.
- Metcalf and Eddy, Inc. 1991. *Wastewater Engineering: Treatment, Disposal, and Reuse 3<sup>rd</sup> ed.* New York: McGraw-Hill.
- MFC. 2000. *Mississippi's BMPs: Best Management Practices for Forestry in Mississippi*. Publication # 107.
- National Atmospheric Deposition Program (NADP). 2001. *NADP/NTN Site List*.
- NRCS. 2000. *Field Office Technical Guide Transmittal No. 61*.
- Pace, Stan. 2001. Personal Communication. Hancock County Extension Agent. Mississippi State University Extension Service.
- Telis, Pamela A. 1992. *Techniques for Estimating 7-Day, 10-Year Low Flow Characteristics for Ungaged Sites on Streams in Mississippi*. U.S. Geological Survey, Water Resources Investigations Report 91-4130.
- Thornton, Kent. 2007. *Memorandum: Suggested Nutrient Thresholds for Bay St. Louis Stream TMDLs*. FTN.
- U.S. Department of Agriculture (USDA). 2001. *1997 Census of Agriculture*. National Agricultural Statistics Service.
- USEPA. 1999. *Protocol for Developing Nutrient TMDLs*. U.S. Environmental Protection Agency, Office of Water, Washington, D.C. EPA 841-B-99-007.

USEPA. 1998. *Better Assessment Science Integrating Point and Nonpoint Sources, BASINS, Version 2.0 User's Manual*. U.S. Environmental Protection Agency, Office of Water, Washington, D.C.

USEPA. 1997. *Technical Guidance Manual for Developing Total Maximum Daily Loads, Book 2: Streams and Rivers, Part 1: Biochemical Oxygen Demand/Dissolved Oxygen and Nutrients/Eutrophication*. United States Environmental Protection Agency, Office of Water, Washington, D.C. EPA 823-B-97-002.

USEPA. 1993. *Handbook: Urban Runoff Pollution Prevention and Control Planning*. Office of Research and Development, Cincinnati, OH. EPA/625/R-93/004.

USGS. 2000. *Airborne Nitrogen Contributes Pollution to U.S. Estuaries*. News Release, Reston, VA.

## DEFINITIONS

**Ambient Stations:** A network of fixed monitoring stations established for systematic water quality sampling at regular intervals, and for uniform parametric coverage over a long-term period.

**Assimilative Capacity:** The capacity of a body of water or soil-plant system to receive wastewater effluents or sludge without violating the provisions of the State of Mississippi Water Quality Criteria for Intrastate, Interstate, and Coastal Waters and Water Quality regulations.

**Background:** The condition of waters in the absence of man-induced alterations based on the best scientific information available to MDEQ. The establishment of natural background for an altered water body may be based upon a similar, unaltered or least impaired, water body or on historical pre-alteration data.

**Biological Impairment:** Condition in which at least one biological assemblages (e.g. , fish, macroinvertebrates, or algae) indicates less than full support with moderate to severe modification of biological community noted.

**Calibrated Model:** A model in which reaction rates and inputs are significantly based on actual measurements using data from surveys on the receiving water body.

**Critical Condition:** Hydrologic and atmospheric conditions in which the pollutants causing impairment of a water body have their greatest potential for adverse effects.

**Daily Discharge:** The “discharge of a pollutant” measured during a calendar day or any 24-hour period that reasonably represents the calendar day for purposes of sampling. For pollutants with limitations expressed in units of mass, the "daily discharge" is calculated as the total mass of the pollutant discharged over the day. For pollutants with limitations expressed in other units of measurement, the "daily average" is calculated as the average.

**Designated Use:** Use specified in water quality standards for each water body or segment regardless of actual attainment.

**Dissolved Oxygen:** The amount of oxygen dissolved in water. It also refers to a measure of the amount of oxygen that is available for biochemical activity in a water body. The maximum concentration of dissolved oxygen in a water body depends on temperature, atmospheric pressure, and dissolved solids.

**First Order Kinetics:** Describes a reaction in which the rate of transformation of a pollutant is proportional to the amount of that pollutant in the environmental system.

**Groundwater:** Subsurface water in the zone of saturation. Groundwater infiltration describes the rate and amount of movement of water from a saturated formation.

**Impaired Water body:** Any water body that does not attain water quality standards due to an individual pollutant, multiple pollutants, pollution, or an unknown cause of impairment.

**Land Surface Runoff:** Water that flows into the receiving stream after application by rainfall or irrigation. It is a transport method for non-point source pollution from the land surface to the receiving stream.

**Load Allocation (LA):** The portion of receiving water's loading capacity attributed to or assigned to non-point sources (NPS) or background sources of a pollutant

**Loading:** The total amount of pollutants entering a stream from one or multiple sources.

**Mass Balance:** An equation that accounts for the flux of mass going into a defined area and the flux of mass leaving a defined area, the flux in must equal the flux out.

**Non-point Source:** Pollution that is in runoff from the land. Rainfall, snowmelt, and other water that does not evaporate become surface runoff and either drains into surface waters or soaks into the soil and finds its way into groundwater. This surface water may contain pollutants that come from land use activities such as agriculture; construction; silviculture; surface mining; disposal of wastewater; hydrologic modifications; and urban development.

**NPDES Permit:** An individual or general permit issued by the Mississippi Environmental Quality Permit Board pursuant to regulations adopted by the Mississippi Commission on Environmental Quality under Mississippi Code Annotated (as amended) §§ 49-17-17 and 49-17-29 for discharges into State waters.

**Photosynthesis:** The biochemical synthesis of carbohydrate based organic compounds from water and carbon dioxide using light energy in the presence of chlorophyll.

**Point Source:** Pollution loads discharged at a specific location from pipes, outfalls, and conveyance channels from either wastewater treatment plants or industrial waste treatment facilities. Point sources can also include pollutant loads contributed by tributaries to the main receiving stream.

**Pollution:** Contamination, or other alteration of the physical, chemical, or biological properties, of any waters of the State, including change in temperature, taste, color, turbidity, or odor of the waters, or such discharge of any liquid, gaseous, solid, radioactive, or other substance, or leak into any waters of the State, unless in compliance with a valid permit issued by the Permit Board.

**Publicly Owned Treatment Works (POTW):** A waste treatment facility owned and/or operated by a public body or a privately owned treatment works which accepts discharges which would otherwise be subject to Federal Pretreatment Requirements.

**Reaeration:** The net flux of oxygen occurring from the atmosphere to a body of water across the water surface.

**Regression Coefficient:** An expression of the functional relationship between two correlated variables that is often empirically determined from data, and is used to predict values of one variable when given values of the other variable.

**Storm Runoff:** Rainfall that does not evaporate or infiltrate the ground because of impervious land surfaces or a soil infiltration rate than rainfall intensity, but instead flows into adjacent land or water bodies or is routed into a drain or sewer system.

**Total Maximum Daily Load or TMDL:** The calculated maximum permissible pollutant loading to a water body at which water quality standards can be maintained.

**Waste:** Sewage, industrial wastes, oil field wastes, and all other liquid, gaseous, solid, radioactive, or other substances which may pollute or tend to pollute any waters of the State.

**Wasteload Allocation (WLA):** The portion of a receiving water's loading capacity attributed to or assigned to point sources of a pollutant.

**Water Quality Standards:** The criteria and requirements set forth in *State of Mississippi Water Quality Criteria for Intrastate, Interstate, and Coastal Waters*. Water quality standards are standards composed of designated present and future most beneficial uses (classification of waters), the numerical and narrative criteria applied to the specific water uses or classification, and the Mississippi antidegradation policy.

**Water Quality Criteria:** Elements of State water quality standards, expressed as constituent concentrations, levels, or narrative statements, representing a quality of water that supports the present and future most beneficial uses.

**Waters of the State:** All waters within the jurisdiction of this State, including all streams, lakes, ponds, wetlands, impounding reservoirs, marshes, watercourses, waterways, wells, springs, irrigation systems, drainage systems, and all other bodies or accumulations of water, surface and underground, natural or artificial, situated wholly or partly within or bordering upon the State, and such coastal waters as are within the jurisdiction of the State, except lakes, ponds, or other surface waters which are wholly landlocked and privately owned, and which are not regulated under the Federal Clean Water Act (33 U.S.C.1251 et seq.).

**Watershed:** The area of land draining into a stream at a given location.

## ABBREVIATIONS

BASINS .....	Better Assessment Science Integrating Point and Nonpoint Sources
BMP .....	Best Management Practice
CWA .....	Clean Water Act
DC .....	District Conservationist
DEM.....	Digital Elevation Model
DO.....	Dissolved Oxygen
EFDC .....	Environmental Fluid Dynamics Code
EPA.....	Environmental Protection Agency
GIS .....	Geographic Information System
HSPF.....	Hydrologic Simulation Program Fortran
HUC .....	Hydrologic Unit Code
LA .....	Load Allocation
MARIS.....	Mississippi Automated Resource Information System
MDEQ.....	Mississippi Department of Environmental Quality
MGD .....	Million Gallons per Day
MSU .....	Mississippi State University
MOS.....	Margin of Safety
NPDES.....	National Pollution Discharge Elimination System
NPSM.....	Non-Point Source Model
NTF.....	Nutrient Task Force
TBOD <sub>u</sub> .....	Total Biochemical Oxygen Demand Ultimate
TMDL .....	Total Maximum Daily Load
TN .....	Total Nitrogen

TP ..... Total Phosphorous  
TTU ..... Tennessee Technological University  
USGS ..... United States Geological Survey  
WASP ..... Water Analysis Simulation Program  
WLA ..... Waste Load Allocation